

the bio Flame™

24" REMOTE CONTROL BURNER

8,840 BTU - 16,300 BTU (4.8 kW·h)

Heats an average of 60m² or 650ft²

304 Stainless Steel Construction

Insulated Bottom Tray

5L Fuel Capacity

24" (610mm) L x 7.6" (193mm) W x 6.6" (168mm) H

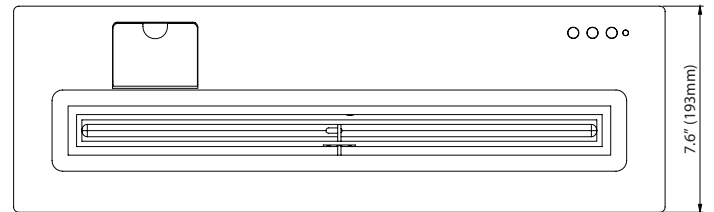

TOP VIEW

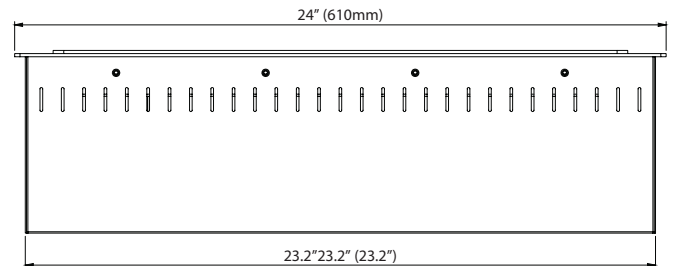

FRONT VIEW

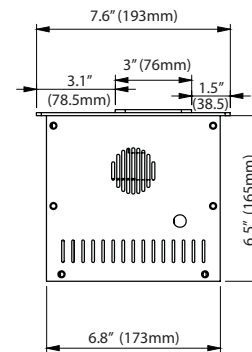

SIDE VIEW

CLEARANCES

INSERTING WITHIN A FIREBOX SETTING

The Bio Flame 24" RC BURNER can only be fitted into a non-combustible firebox that has minimum clearances of 32"W x 20"H x 15"D

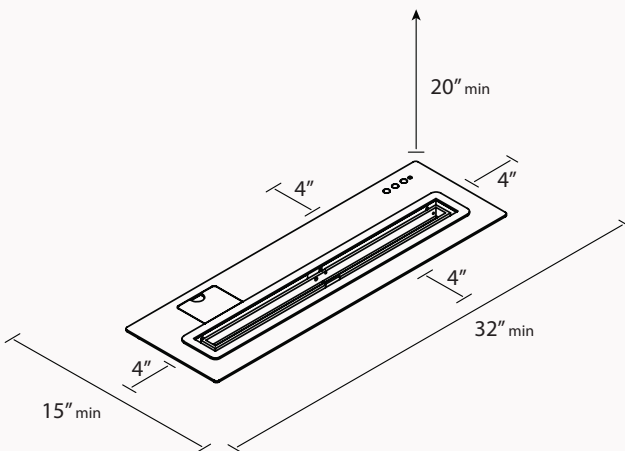

* Dimensions may vary due to material attributes. Template not provided.

The Bio Flame recommends using the actual fireplace or burner model when making final cut out